

Sizing Chart for Sewing and Crafts

Courtesy of:
Sher's Creative Space

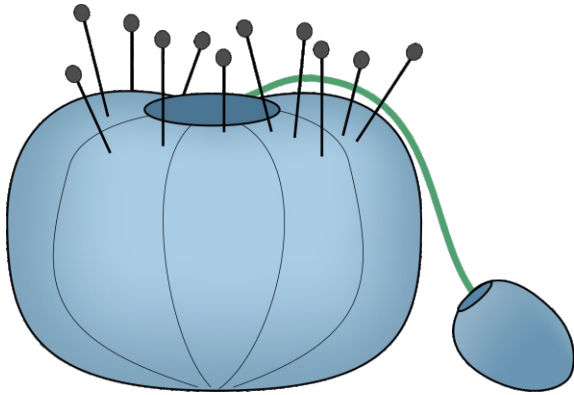

MILLIMETER DIAMETER CIRCLES

Pom Poms, Rings, Buttons, Balls, Sequins, Stones, Wiggle Eyes, Beads, Etc.

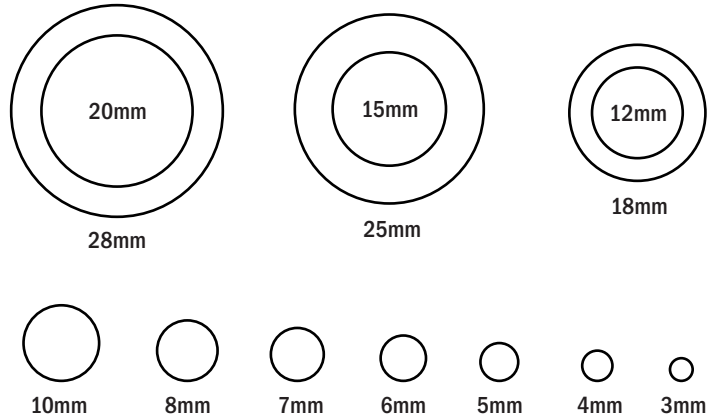

RIBBON SIZES

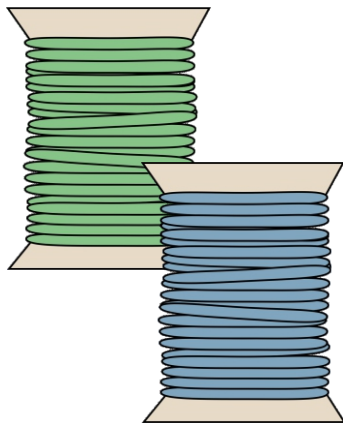
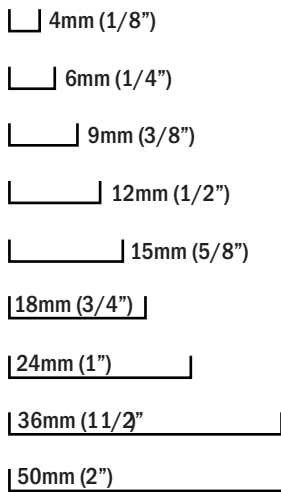

INCH DIAMETER CIRCLES

Pom Poms, Rings, Buttons, Balls, Sequins, Stones, Wiggle Eyes, Beads, Etc.

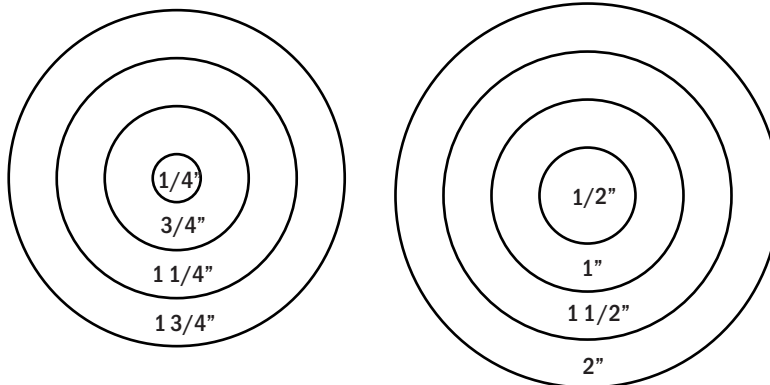

MILLIMETER DIAMETER CORDING

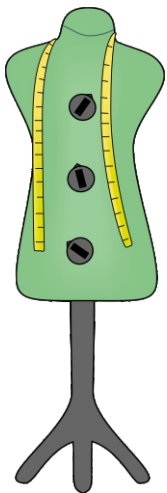
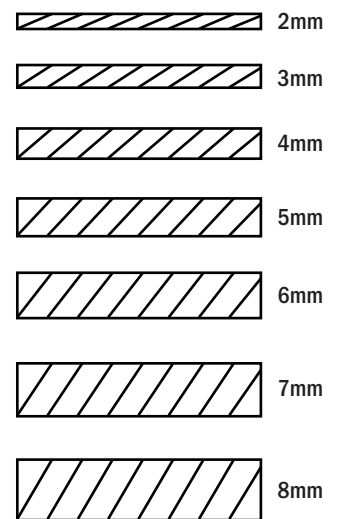

If this space measures 1/2 x 3 inches, then your size chart is accurate!

or

If this space measures 10 x 70 mm, then your size chart is accurate!

This sheet MUST be printed at 100% or Actual Size

©SherylHastings2015 Please do not redistribute this chart in any way.